



PETER CLAASSEN

DUBBELE BEDIENINGEN



Onderhoudsplan & Waarborging



Wartungsplan & Garantiesiegel



Maintenance plan & warranty seal

Peter Claassen inbouwstation BV, Duikerweg 21, 5145NV, Waalwijk, the Netherlands



Onderhoudsplan & Waarborging voor uw veiligheid

Voor veiligheidsredenen dient het onderhoudsplan & waarborging gevolgd te worden. Wij hebben alle door ons bepaalde cruciale verbindingen gemarkeerd met een Tamper- Evident Marker. Deze markeringen dienen dan ook volgens onderhoudsplan gecontroleerd te worden. Dit doen wij om ervoor te zorgen dat garagebedrijven en personen niet buiten ons weten om aan ons systeem zitten. Zo voorkomt u dat u of een ander in een gevaarlijke situatie terecht komen. Breng dit dan ook altijd onder de aandacht van uw garage. U dient een schriftelijke goedkeuring te krijgen van Peter Claassen inbouwstation BV voor het verbreken van de markeringen met het los halen of verschuiven van onderdelen.

Het Peheja systeem is onderhoudsgevoelig en u dient het onderhoudsplan zorgvuldig op te volgen. Indien het onderhoudsplan en of waarborging niet wordt nageleefd komen alle garanties, aansprakelijkheid & claims op ons systeem en bedrijf, in welke vorm dan ook te vervallen.



Wartungsplan & Garantiesiegel

Aus Sicherheitsgründen müssen der Wartungsplan & Garantiesiegel eingehalten werden.
Wir haben alle kritischen Verbindungen, die wir ermittelt haben, mit einem Tamper- Evident Marker markiert. Diese Markierungen müssen daher gemäß dem Wartungsplan überprüft werden.
Wir tun dies, um sicherzustellen, dass Werkstätten oder Personen unser System nicht ohne unser Wissen manipulieren. Dadurch wird verhindert, dass Sie oder jemand anderes in eine gefährliche Situation geraten. Machen Sie Ihre Werkstatt immer darauf aufmerksam. Sie müssen eine schriftliche Genehmigung von Peter Claassen inbouwstation BV einholen, um die Markierungen durch Entfernen oder Bewegen von Teilen zu zerstören.

Das Peheja-System ist wartungsempfindlich und Sie müssen den Wartungsplan sorgfältig einhalten.
Wenn der Wartungsplan und / oder Garantiesiegel nicht eingehalten werden, erlöschen alle Garantien, Haftungen und Ansprüche auf unser System und unser Unternehmen, in welcher Form auch immer.



Onderhoudsplan & Waarborging

Om veiligheids- en kwaliteitsredenen moet het onderstaande onderhoudsplan worden nageleefd. Het niet naleven hiervan kan leiden tot overlijden, ernstig lichamelijk letsel of ernstige verkeersongevallen.



Wartungsplan & Garantiesiegel

Aus Sicherheits- und Qualitätsgründen muss der folgende Wartungsplan eingehalten werden. Bei Nichtbeachtung können Todesfälle, schwere Körperverletzungen oder schwere Verkehrsunfälle die Folge sein.



Maintenance plan & warranty seal

For safety and quality reasons, the following maintenance schedule must be observed. Failure to do so may result in death, serious injury or serious traffic accidents.





 **Onderhoudsplan**

 **Wartungsplan**

Pos	Omschrijving	Qualif	Interval in km					3-4 year	5-8 year
			15.000-20.000	50.000-60.000	150.000-200.000	250.000-300.000			
1	Boutverbindingen*	F/T	Check						
2	Boutverbindingen*	T		Check				Check	
3	Zoemersysteem	F	Check						
4	Koppeling kabel	M			Vervangen		Vervangen		
5	Rem kabel	M				Vervangen		Vervangen	
6	Gas kabel	F/T	Check					Vervangen	

Kwalificatie	Omschrijving
F	Rijschoolhouder / Rijninstructeur
T	Technisch persoon / garage bedrijf
M	Monteur officiële Peheja dealer



Indien er markeerpunten verbroken zijn kom dan direct langs bij ons voor een controle check.

Pos	Bezeichnung	Qualif	Intervall in km					3-4 Jahre	5-8 Jahre
			15.000-20.000	50.000-60.000	150.000-200.000	250.000-300.000			
1	Schraubverbindungen *	F/T	Überprüfen						
2	Schraubverbindungen *	T		Überprüfen					
3	Funktion des Summers	F	Überprüfen						
4	Seilzüge Kupplung	M			Tauschen		Tauschen		
5	Seilzüge Bremse	M				Tauschen		Tauschen	
6	Seilzüge Gaspedal	F/T	Überprüfen					Tauschen	

Qualifikation	Bezeichnung
F	Farschule
T	Technische Person / Autowerkstatt
M	Mechaniker offiziell Peheja-Händler



Wenn die Markierungspunten gebrochen sind, kommen Sie bitte umgehend zur Kontrollkontrolle zu uns.

* Zie pagina Waarborging

* Siehe Seite Garantiesiegel



 **Maintenance plan**

This document is copyrighted by Peter Claassen inbouwstation bv 5-9-2024

Pos	Description	Qualif	Interval in km					3-4 year	5-8 year
			15.000-20.000	50.000-60.000	150.000-200.000	250.000-300.000			
1	Bolt connections*	F/T	Check						
2	Bolt connections*	T		Check			Check		
3	Function of the buzzer	F	Check						
4	Clutch Cable	M			Replace		Replace		
5	Brake Cable	M				Replace		Replace	
6	Accelerator Cable	F/T	Check					Replace	

Kwalificatie	Omschrijving
F	Driving school owner / Driving instructor
T	Technical person / car garage
M	Mechanic official Peheja dealer

* Zie pagina Waarborging



If any markers are broken, please come to us immediately for a control check.

Quality check Nm



 Om aan de kwaliteitseisen te voldoen, controleert u het Nm van de bouten en de vereiste configuratie volgens ISO Norm.

 To meet the quality requirements please check the Nm of the bolts and in the required configuration according to ISO Standard.

 Um den Qualitätsanforderungen gerecht zu werden, überprüfen Sie die Nm der Schrauben und die benötigte Konfiguration gemäß ISO-Norm.

This document is copyrighted by Peter Claassen inbouwstation bv 5-9-2024

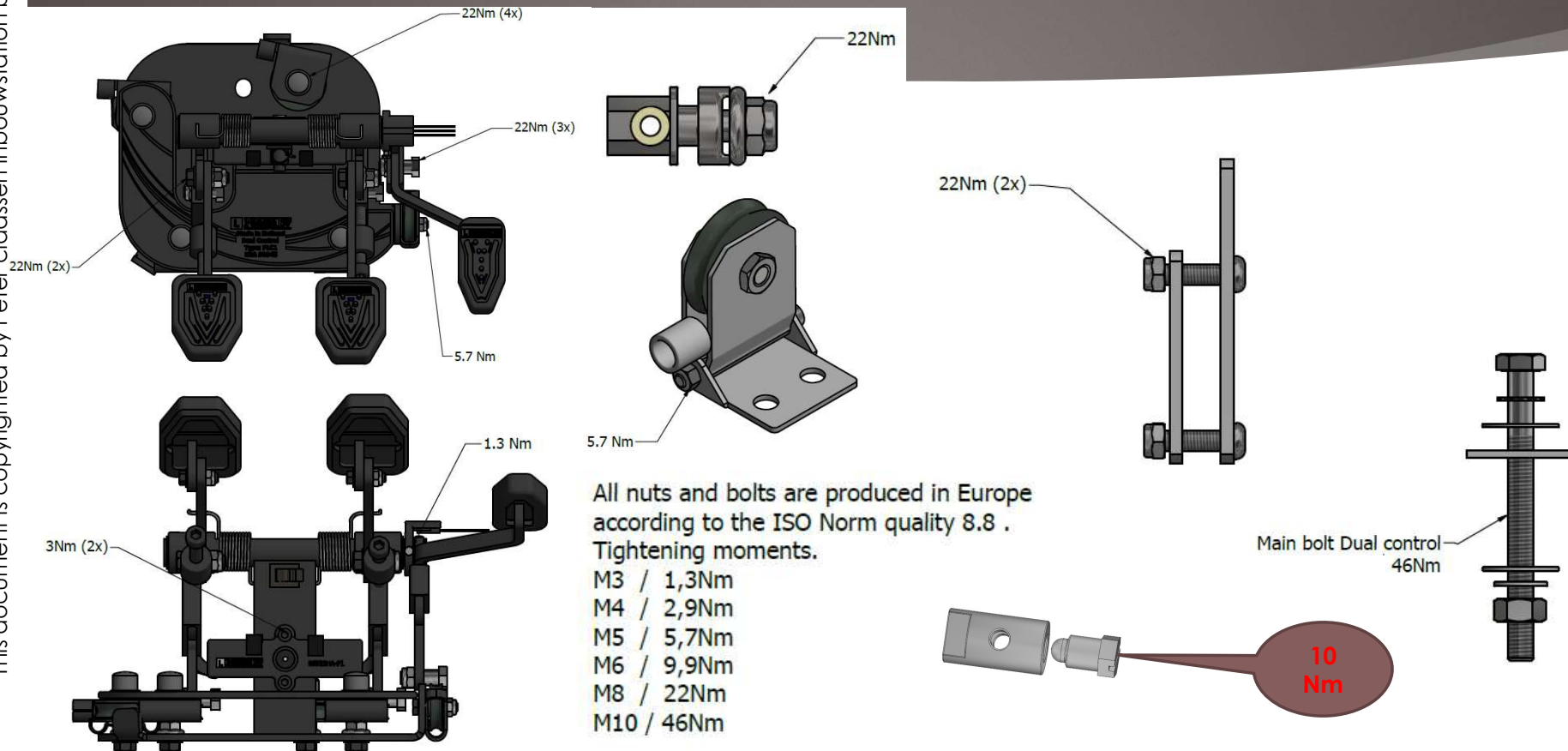



Waarborging:



Alle door ons bepaalde cruciale verbindingen zullen door ons gemarkeerd worden met een Tamper-Evident Marker. Deze markeringen dienen dan ook volgens onderhoudsplan gecontroleerd te worden. Indien buiten onze schriftelijke goedkeur en buiten ons weten om deze marker beschadigt is en of verbroken door het los halen of verschuiven van onderdelen. komen alle garanties, aansprakelijkheid & claims op ons systeem en bedrijf, in welke vorm dan ook te vervallen. Dit staat dan ook niet ter discussie. In de onderstaande bijlage vindt u verschillende markeerpunten, ter indicatie. De markeer punten variëren per voertuig. **Indien er markeerpunten verbroken zijn kom dan direct langs bij ons voor een controle check.**



Garantiesiegel:



Alle von uns festgestellten entscheidenden Verbindungen werden von uns mit einem Tamper-Evident-Marker gekennzeichnet. Deshalb sind diese Markierungen laut Wartungsplan zu kontrollieren. wenn dieser Marker ohne unsere schriftliche Genehmigung und ohne unser Wissen durch Lösen oder Verschieben von Teilen beschädigt oder gebrochen wurde. Sämtliche Gewährleistungen, Haftungen und Ansprüche auf unser System und Unternehmen in welcher Form auch immer sind ungültig. Dies steht daher nicht zur Diskussion. Im Anhang unten finden Sie zur Orientierung verschiedene Markierungspunkte. Die Markierungspunkte variieren je nach Fahrzeug. **Wenn die Markierungspunkten gebrochen sind, kommen Sie bitte umgehend zur Kontrollkontrolle zu uns.**



Warranty seal



All critical connections determined by us will be marked by us with a Tamper-Evident Marker. These markings must therefore be checked according to the maintenance plan. If this marker is damaged and/or broken by loosening or shifting parts without our written approval and without our knowledge, all guarantees, liability & claims on our system and company, in whatever form, will lapse. This is therefore not up for discussion. In the attachment below you will find various marking points, for indication. The marking points vary per vehicle. **If any marking points are broken, come to us immediately for a control check.**

 Waarborging

 Warranty seal

 Garantiesiegel

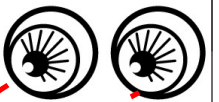

 Waarborging

 Warranty seal

 Garantiesiegel

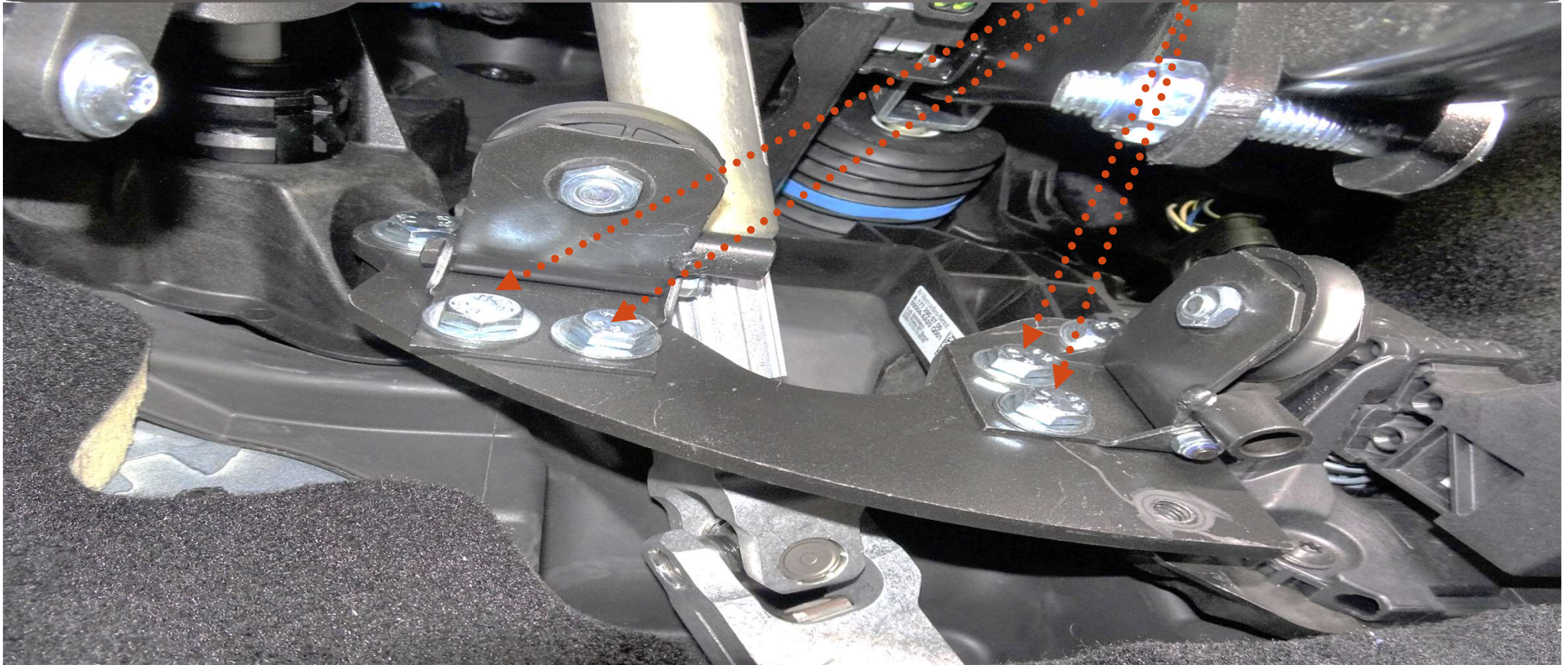

 Waarborging

 Warranty seal

 Garantiesiegel

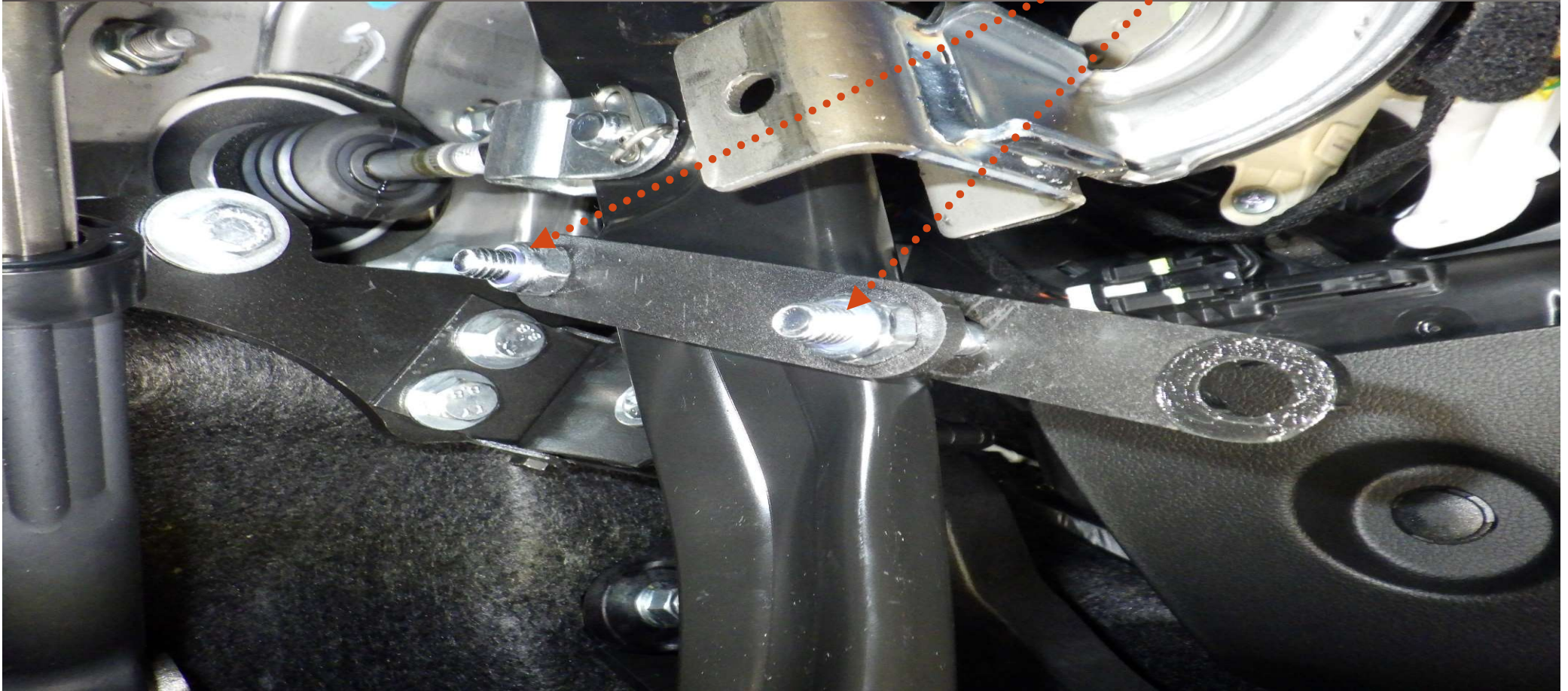

 Waarborging

 Warranty seal

 Garantiesiegel



 Waarborging

 Warranty seal

 Garantiesiegel



 Waarborging
 Garantiesiegel

 Warranty seal



This document is copyrighted by Peter Claassen inbouwstation bv 5-9-2024

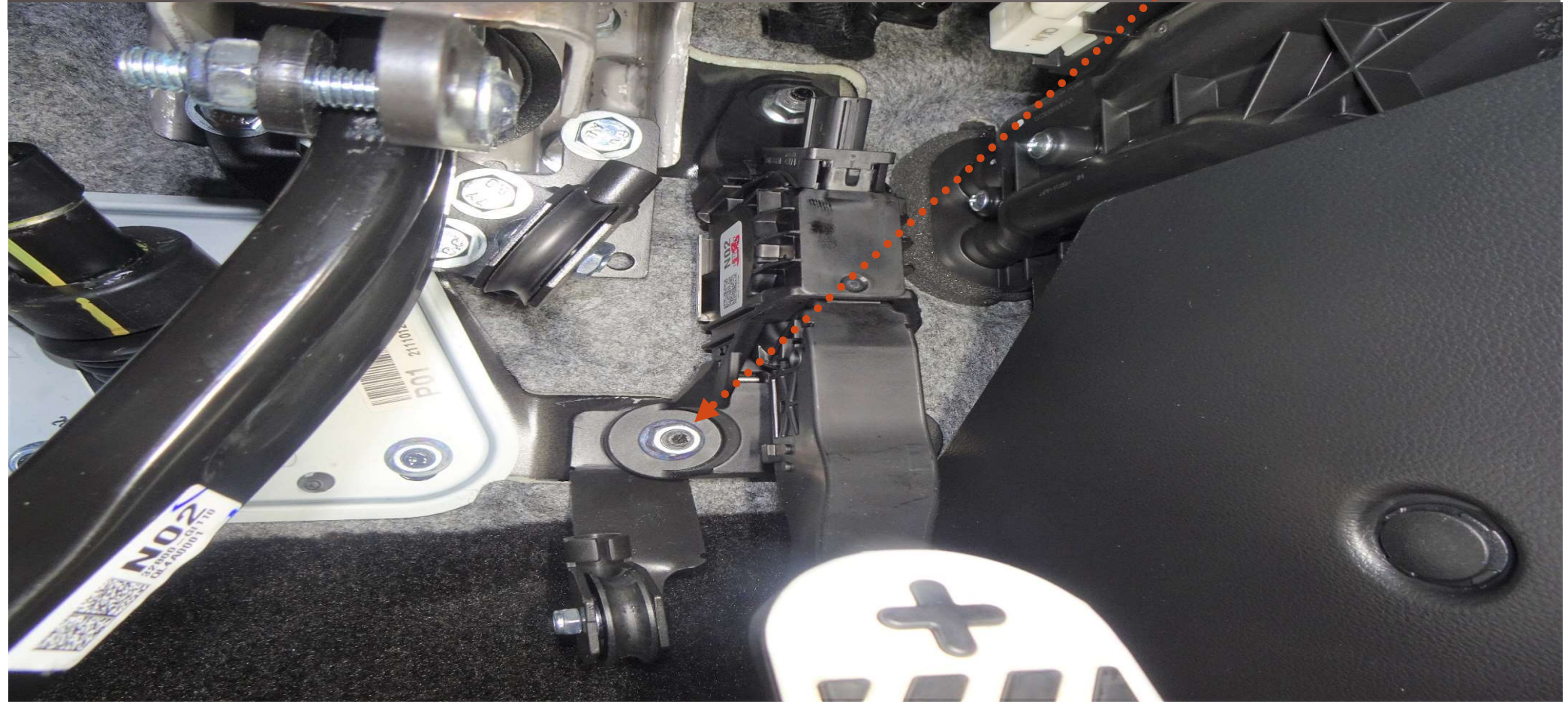

 Waarborging

 Warranty seal

 Garantiesiegel

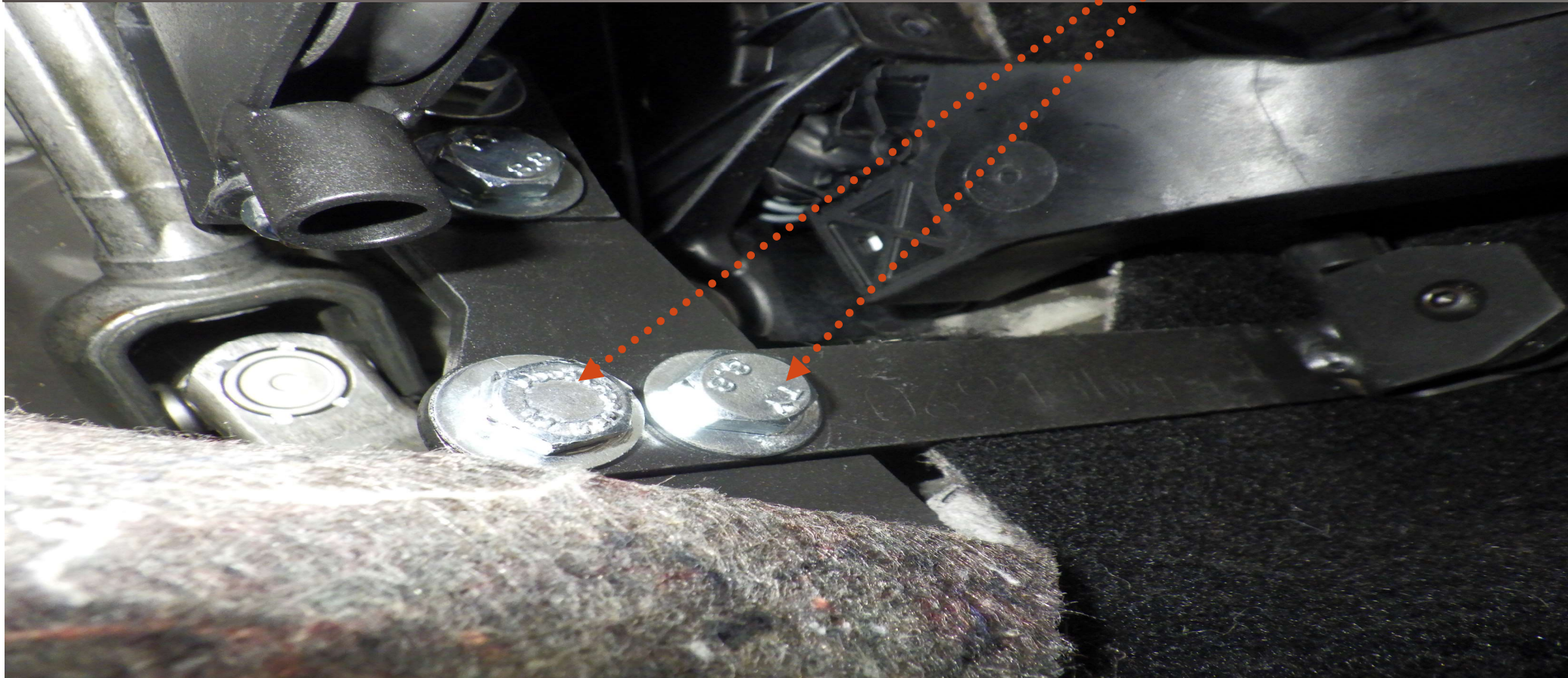

 Waarborging

 Warranty seal

 Garantiesiegel



 Waarborging

 Warranty seal

 Garantiesiegel



 Waarborging

 Warranty seal

 Garantiesiegel



 Waarborging

 Warranty seal

 Garantiesiegel



 Waarborging

 Warranty seal

 Garantiesiegel

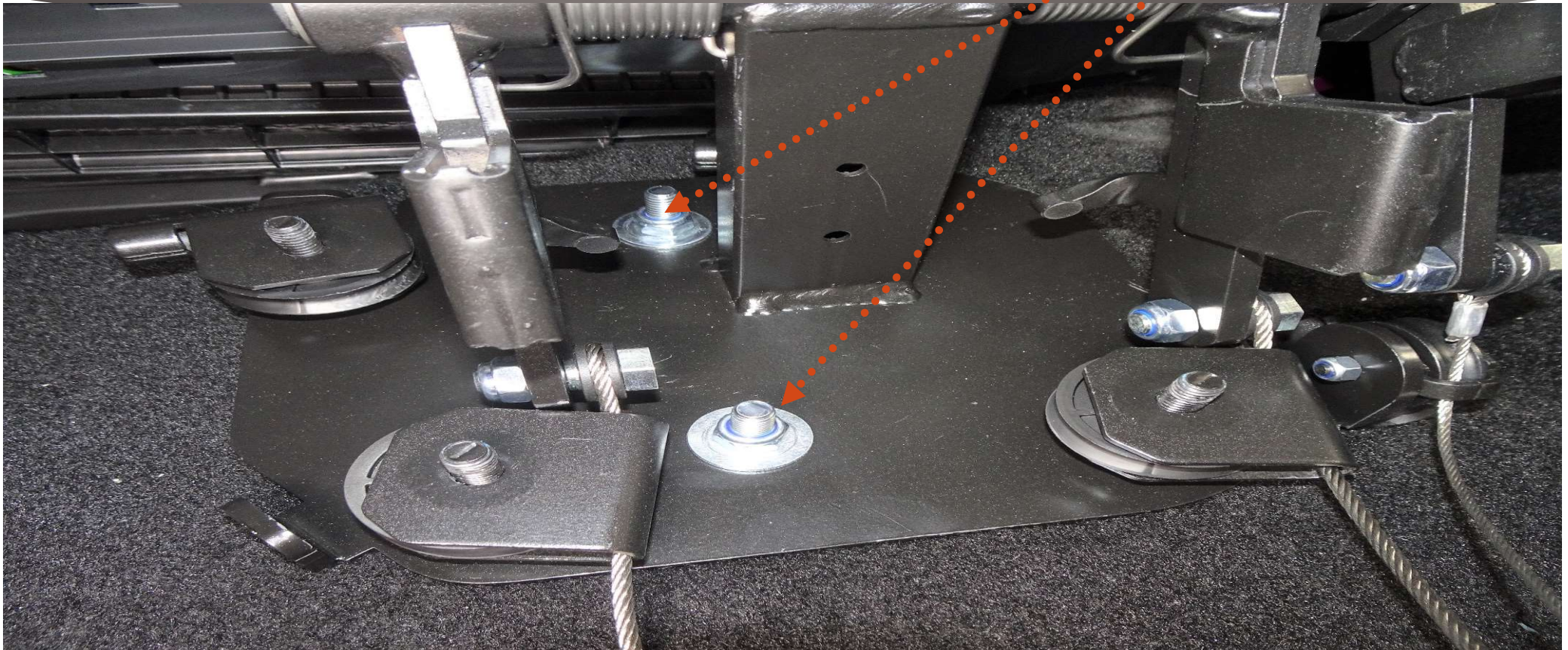

 Waarborging

 Warranty seal

 Garantiesiegel

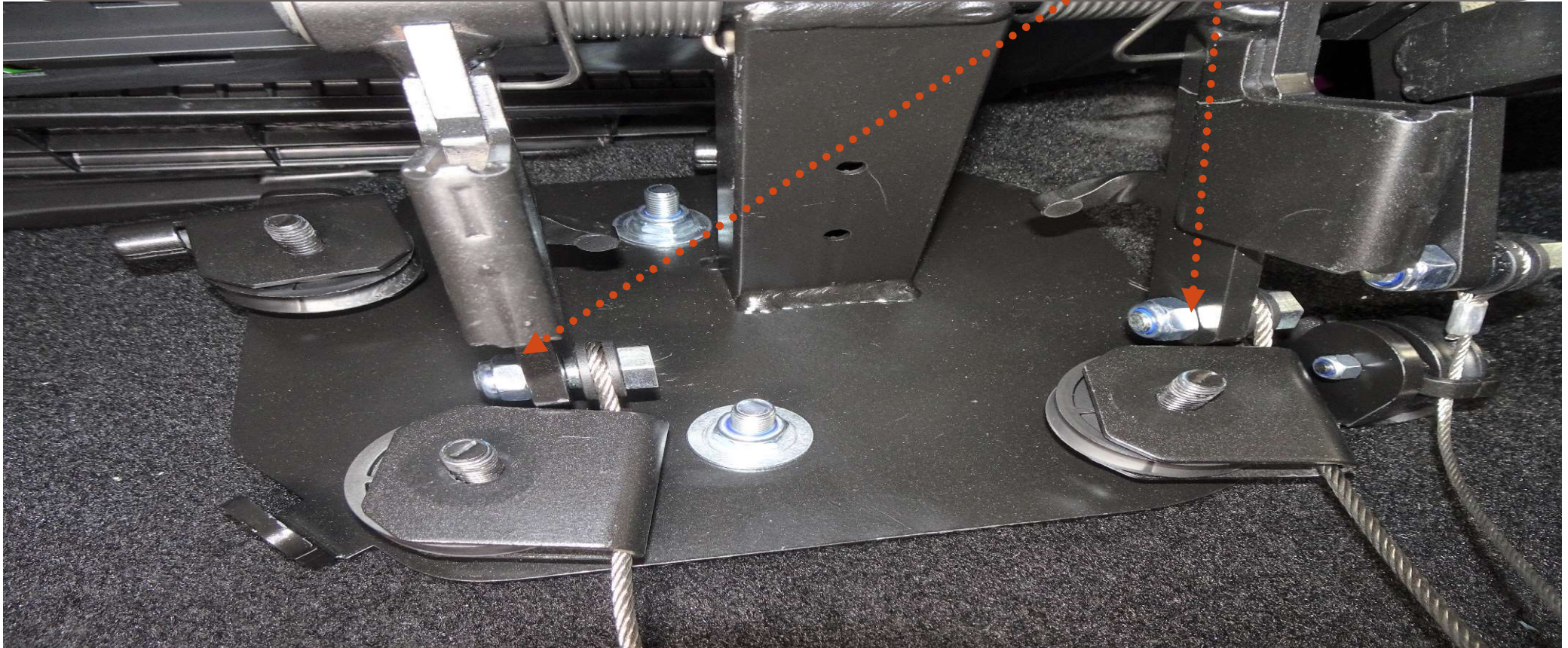

 Waarborging

 Warranty seal

 Garantiesiegel

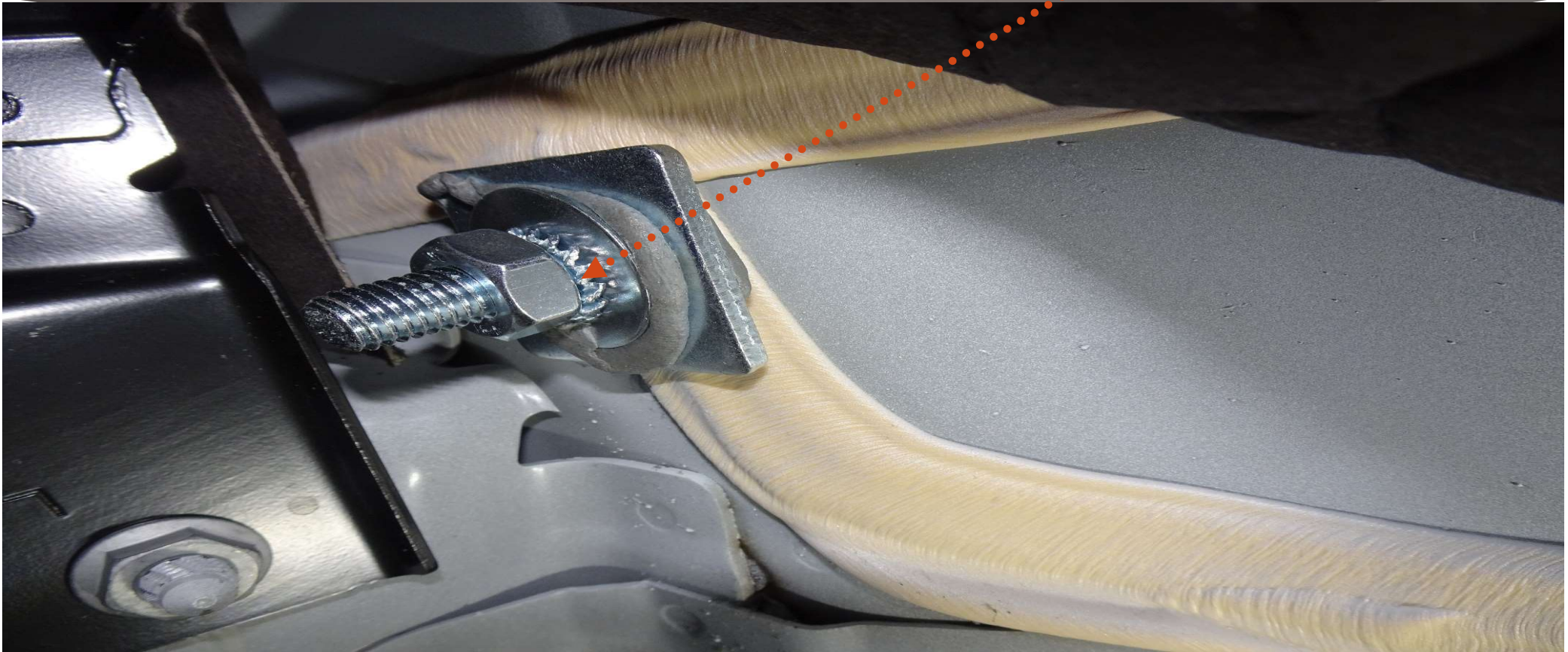

 Waarborging

 Warranty seal

 Garantiesiegel

